

Product title:

# MOTOR SPRING M16LE8965

Product image:

Product price:

**€90.46**

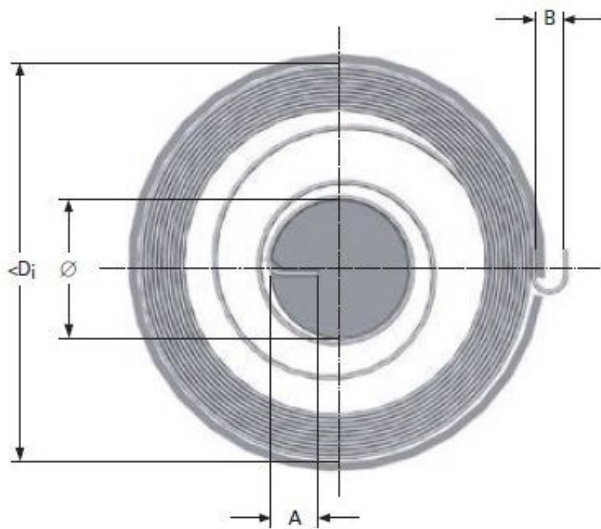

Product short description:

MOTOR SPRING M16LE8965

Product features:

INSIDE DIAMETER: 55  
TOTAL COILS: 10  
RAW MATERIAL THICKNESS: 0.4  
BAND WIDTH: 10  
SHAFT DIAMETER: 12  
LEG LENGTH: 3  
TORQUE: 66  
MAXIMUM TORQUE: 275  
TAIL WIDTH: 4