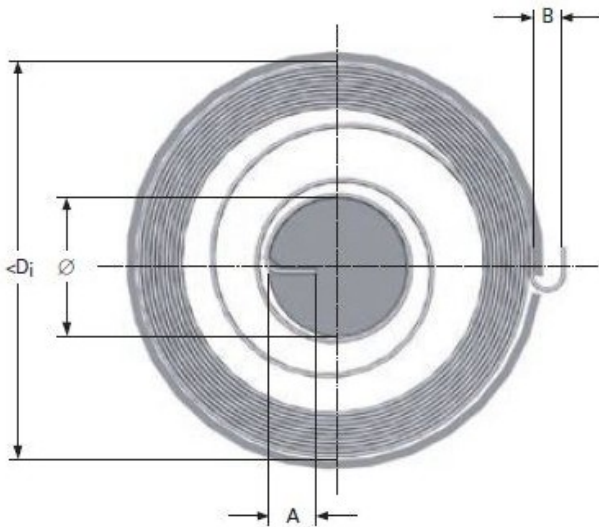

Product title:

# MOTOR SPRING M16LE8992

Product image:

Product price:

**€302.84**

Product short description:

MOTOR SPRING M16LE8992

Product features:

INSIDE DIAMETER: 136  
TOTAL COILS: 20  
RAW MATERIAL THICKNESS: 0.7  
BAND WIDTH: 12  
SHAFT DIAMETER: 20  
LEG LENGTH: 6  
TORQUE: 184  
MAXIMUM TORQUE: 942  
TAIL WIDTH: 6